

SHINDENGEN

Schottky Rectifiers (SBD)

Dual

S1ZAS4

40V 1.2A

FEATURES

- SMT
- Tj150
- P_{RRSM} avalanche guaranteed
- Array

APPLICATION

- Switching power supply
- DC/DC converter
- Home Appliances, Office Equipment
- Telecommunication

OUTLINE DIMENSIONS

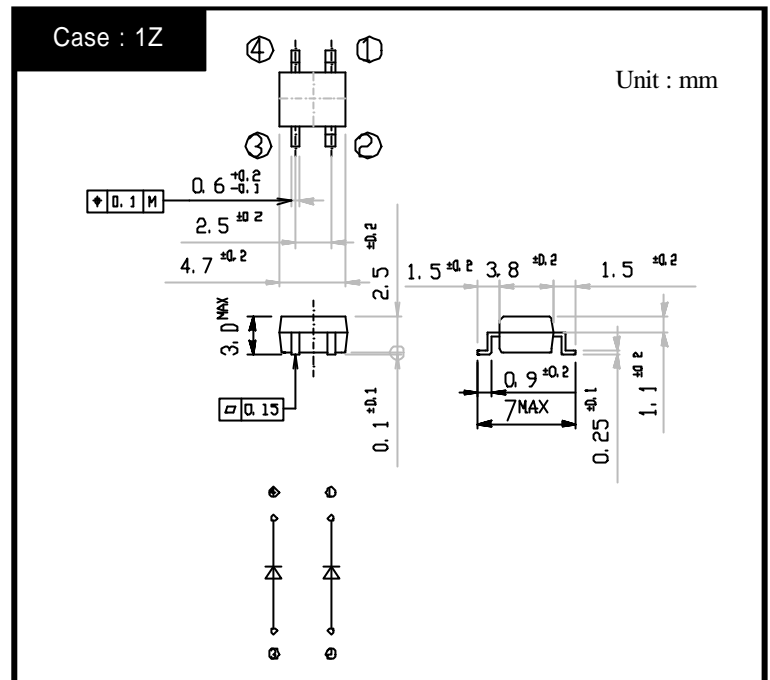

RATINGS

Absolute Maximum Ratings (If not specified Tl=25)

Item	Symbol	Conditions	Ratings	Unit
Storage Temperature	Tstg		-40 ~ 150	
Operating Junction Temperature	Tj		150	
Maximum Reverse Voltage	V _{RM}		40	V
Repetitive Peak Surge Reverse Voltage	V _{RRSM}	Pulse width 0.5ms, duty 1/40	45	V
Average Rectified Forward Current	I _O	50Hz sine wave, R-load, On alumina substrate, 1 element operation, Ta=49	1.2	A
		50Hz sine wave, R-load, On alumina substrate, 2 element operation, Ta=45	0.9*	
		50Hz sine wave, R-load, On glass-epoxy substrate, 1 element operation, Ta=47	1.0	
		50Hz sine wave, R-load, On glass-epoxy substrate, 2 element operation, Ta=43	0.72*	
Peak Surge Forward Current	I _{FSM}	50Hz sine wave, Non-repetitive 1 cycle peak value, Tj=125	40	A
Repetitive Peak Surge Reverse Power	P _{RRSM}	Pulse width 10 μ s, Rating of per diode, Tj=25	160	W

Electrical Characteristics (If not specified Tl=25)

Item	Symbol	Conditions	Ratings	Unit
Forward Voltage	V _F	I _F =1A, Pulse measurement, Rating of per diode	Max.0.55	V
Reverse Current	I _R	V _R =V _{RM} , Pulse measurement, Rating of per diode	Max.1	mA
Junction Capacitance	C _j	f=1MHz, V _R =10V, Rating of per diode	Typ.65	pF
Thermal Resistance	j-l	junction to lead	Max.25	/W
		junction to ambient, On alumina substrate, 1 element operation	Max.93	
		junction to ambient, On alumina substrate, 2 element operation	Max.140*	
		junction to ambient, On glass-epoxy substrate, 1 element operation	Max.120	
		junction to ambient, On glass-epoxy substrate, 2 element operation	Max.186*	

* Rating of per diode

S1ZAS4

Forward Voltage

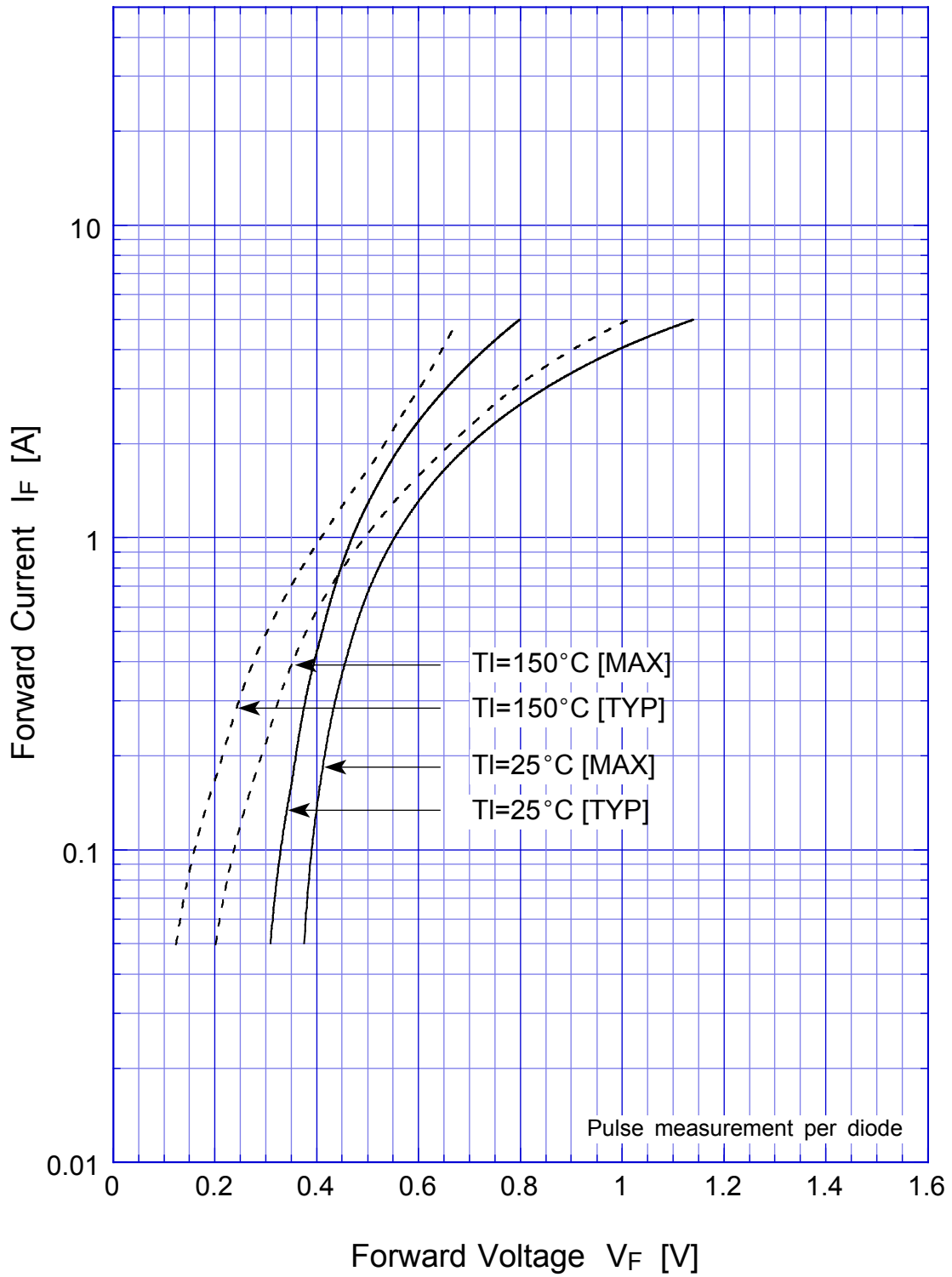

S1ZAS4

Junction Capacitance

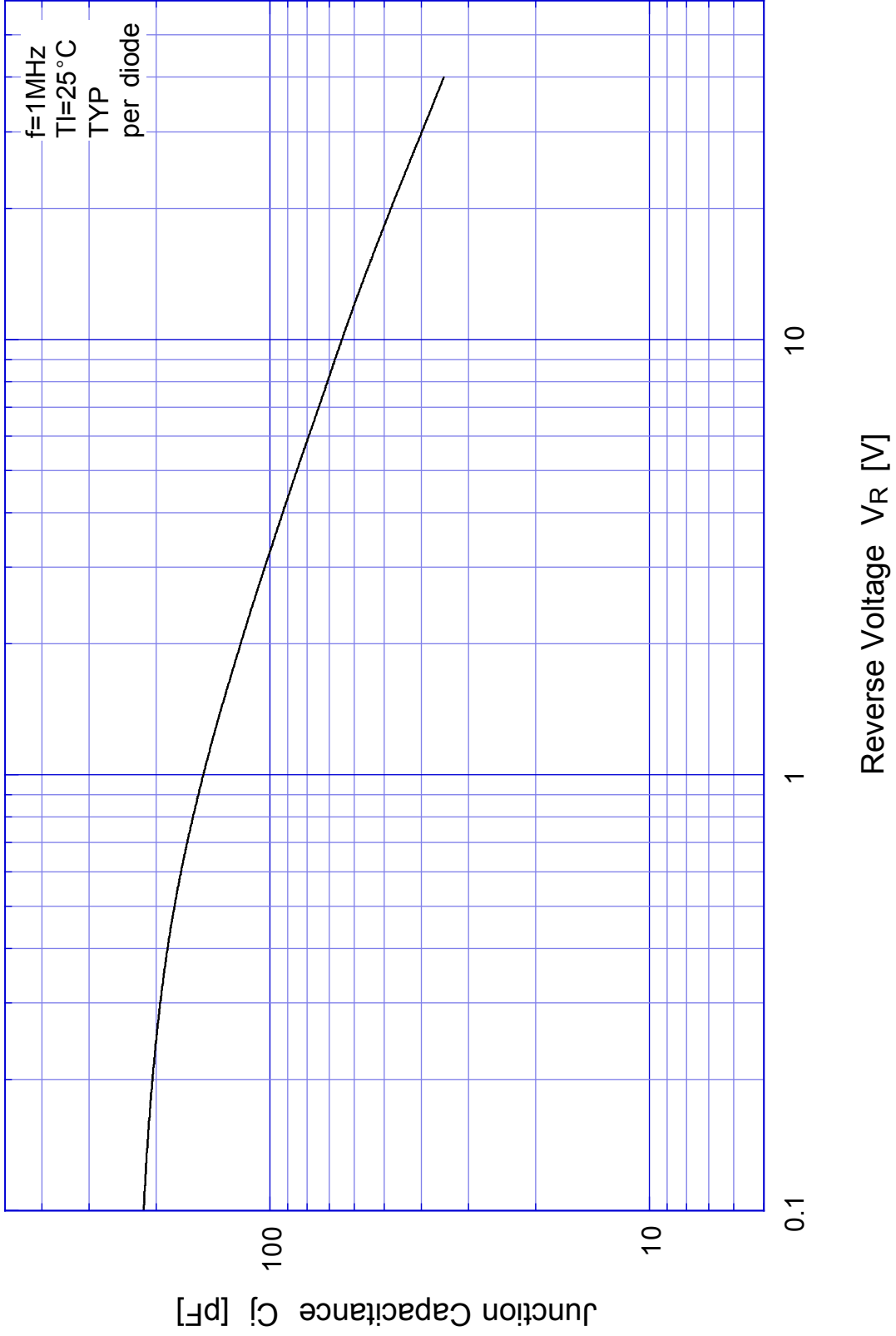

S1ZAS4

Reverse Current

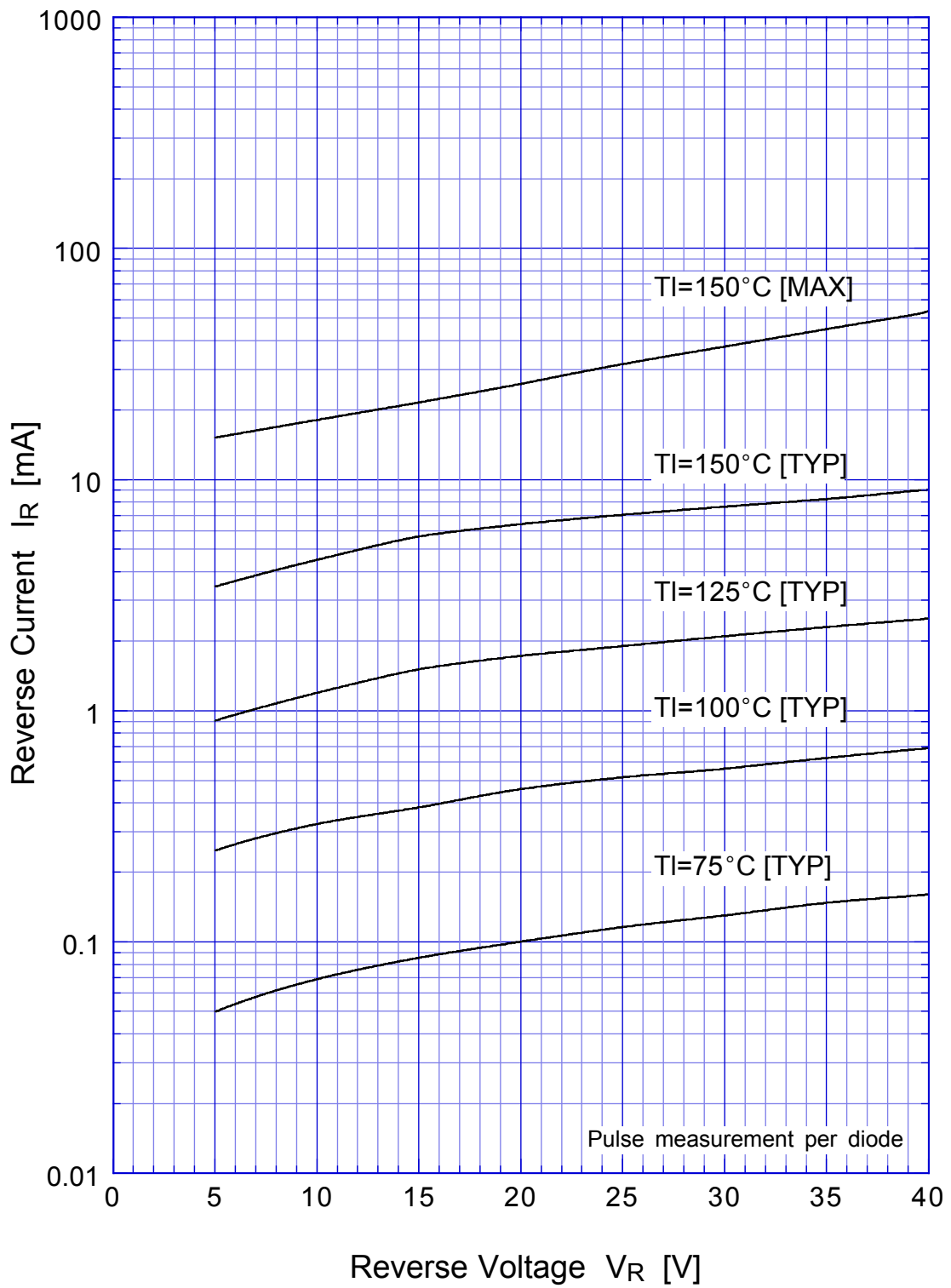

S1ZAS4

Reverse Power Dissipation

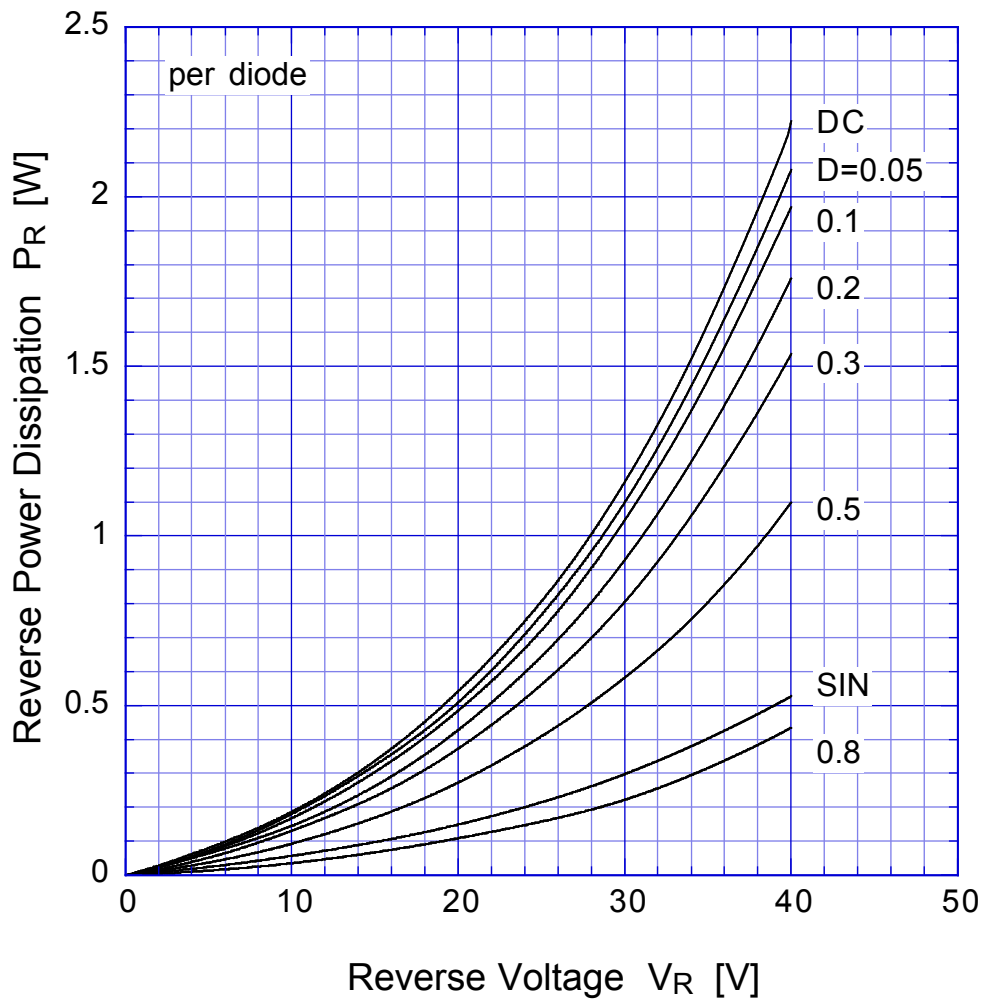

$T_j = 150^\circ\text{C}$

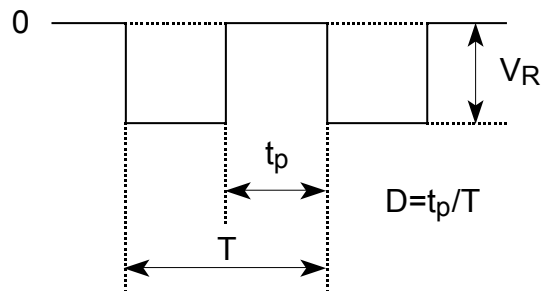

S1ZAS4

Forward Power Dissipation

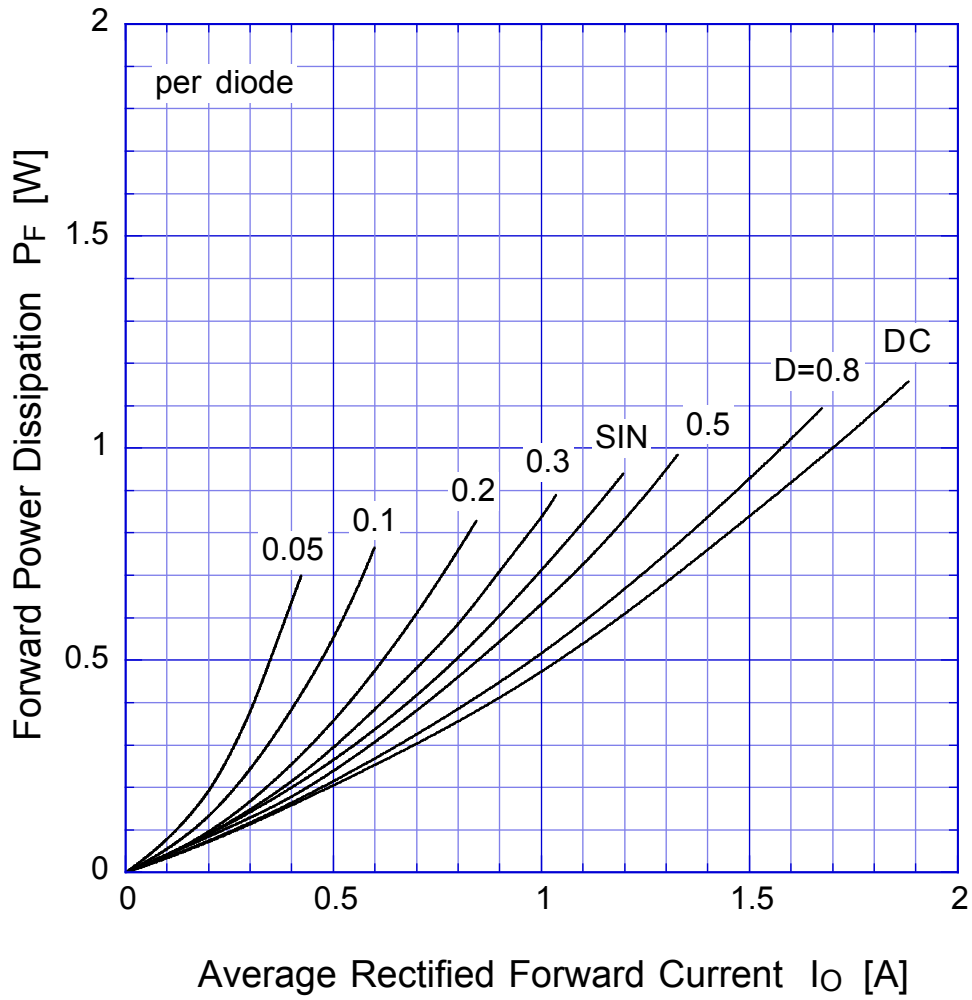

$T_j = 150^\circ\text{C}$

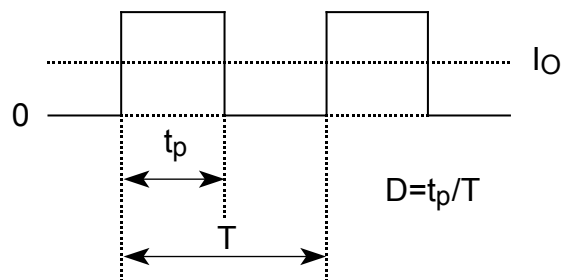

S1ZAS4

Derating Curve

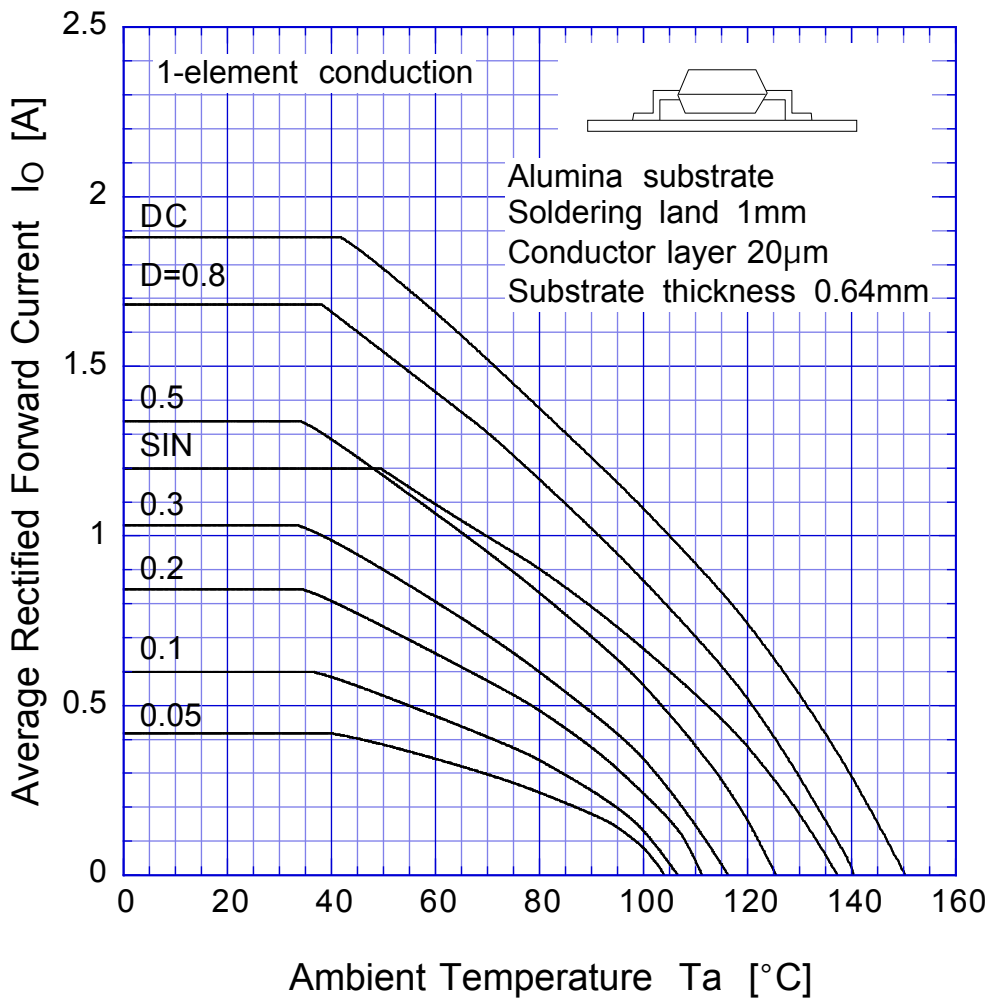

$V_R = 20V$



S1ZAS4

Derating Curve

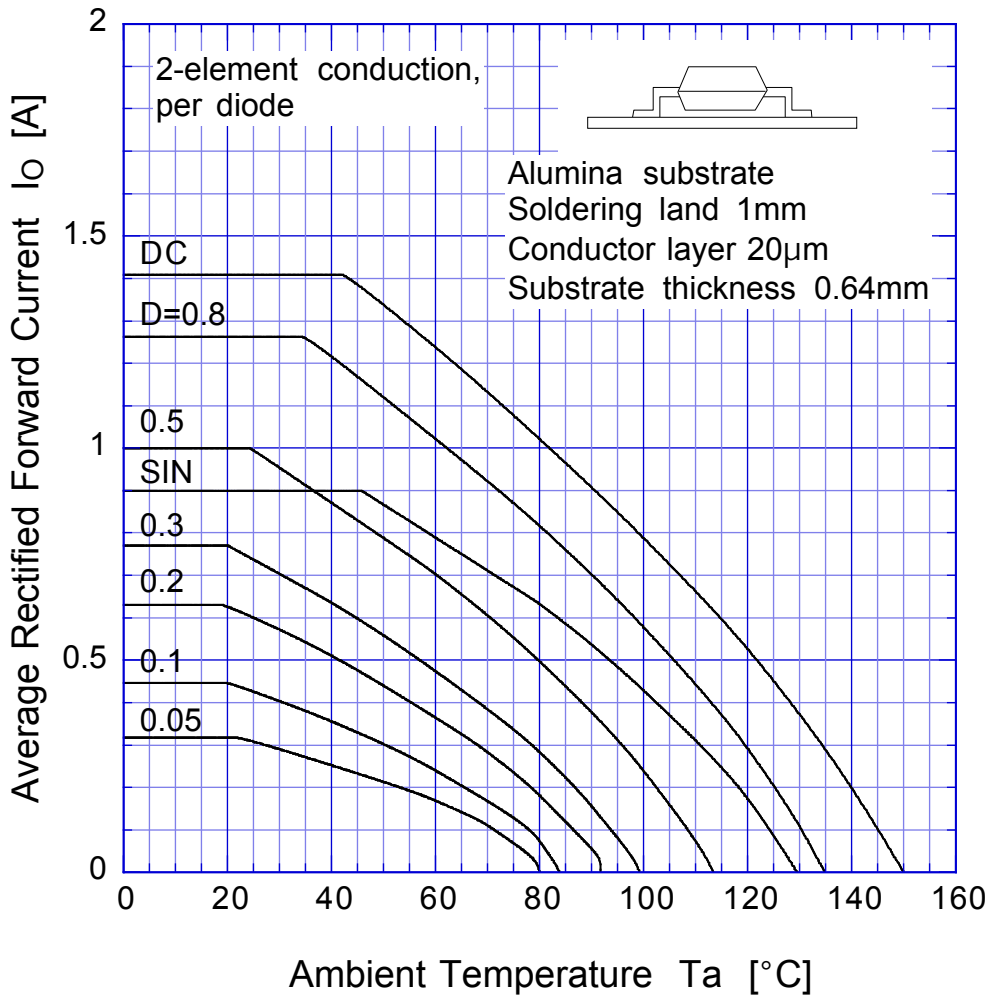

$V_R = 20V$



S1ZAS4

Derating Curve

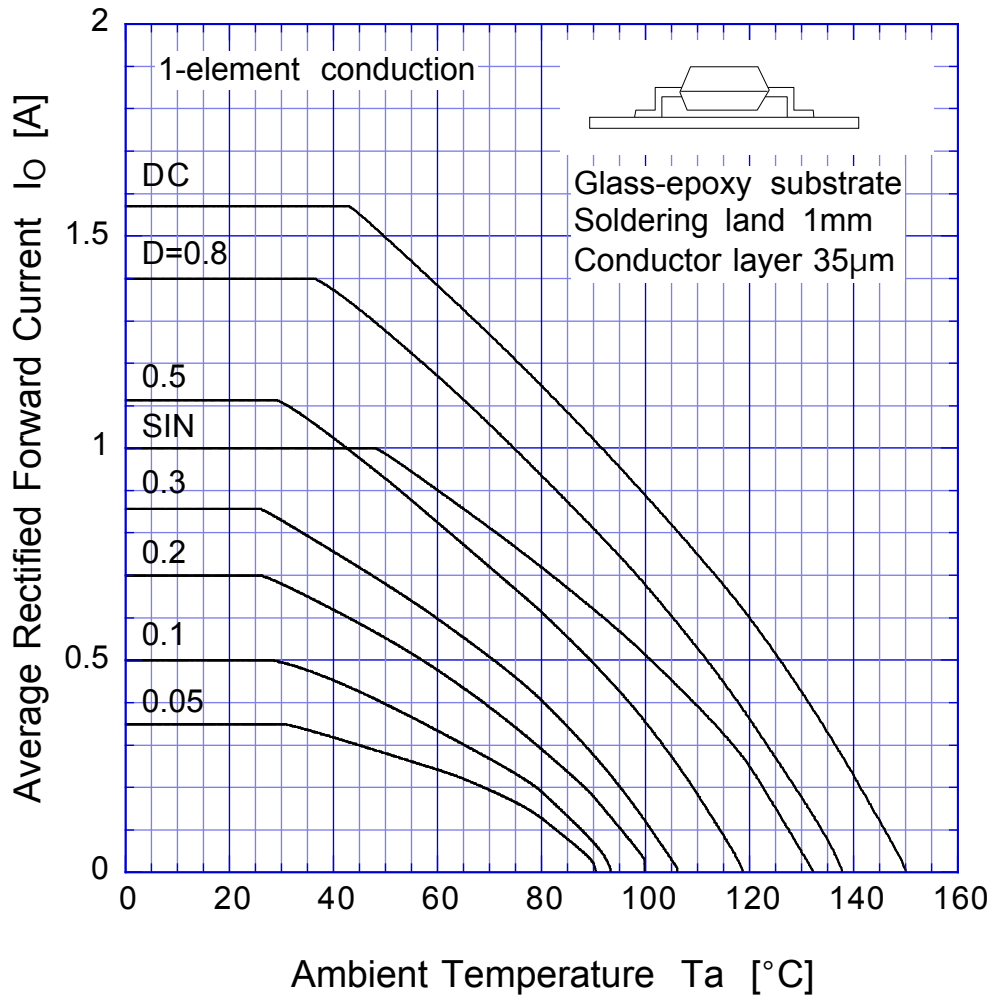

$V_R = 20V$

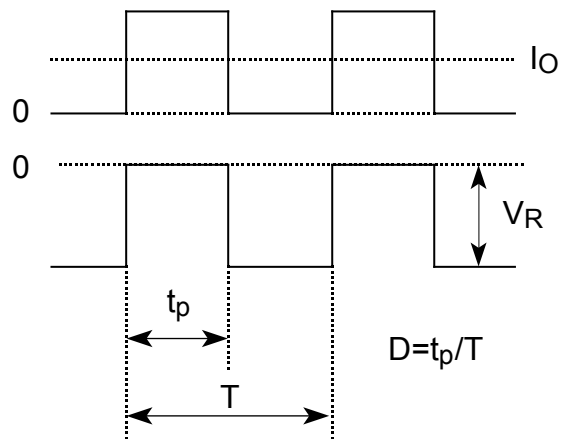

S1ZAS4

Derating Curve

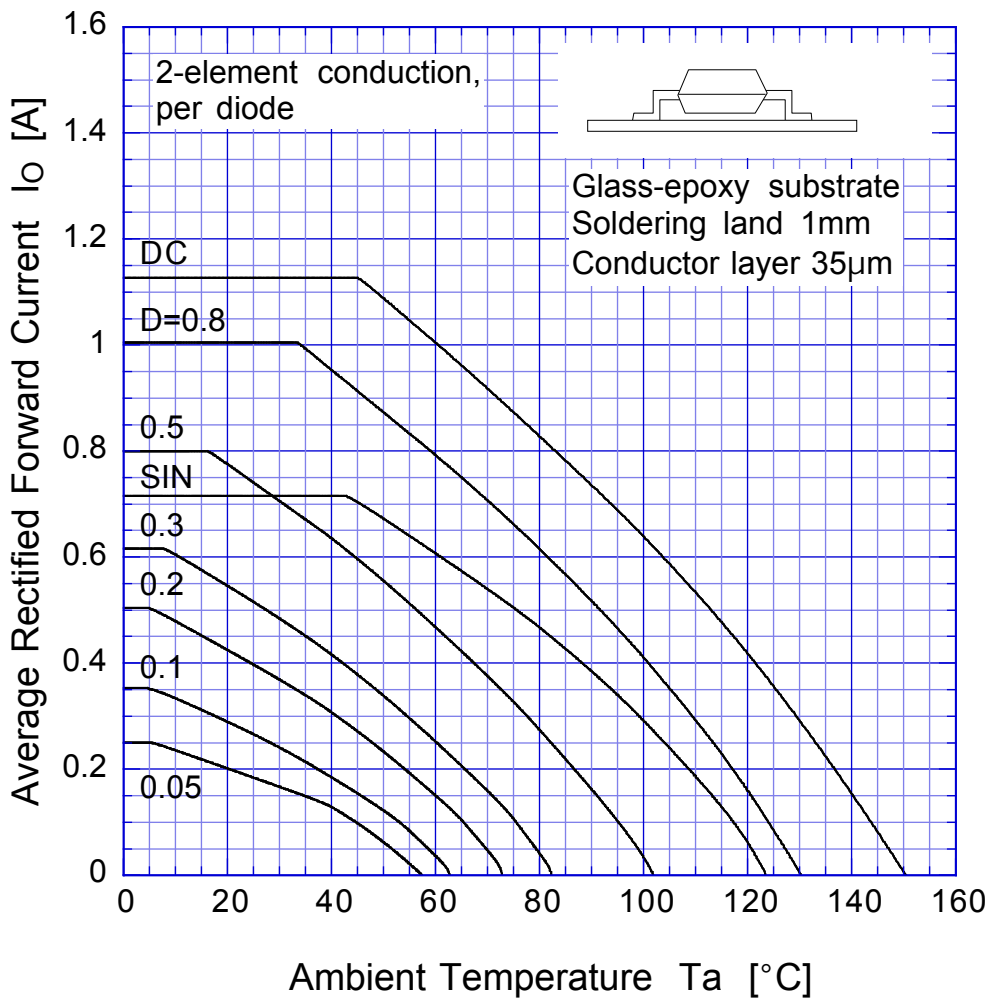

$V_R = 20V$

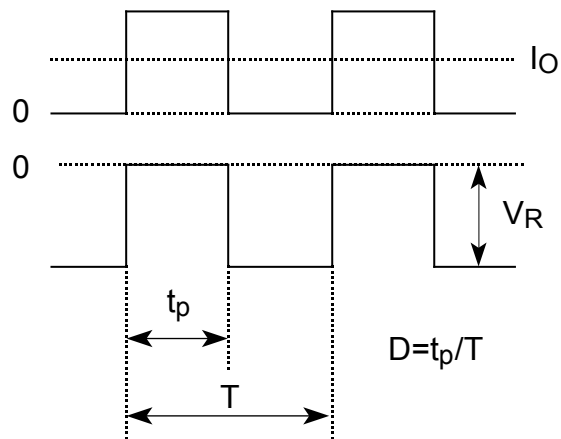

S1ZAS4

Peak Surge Forward Capability

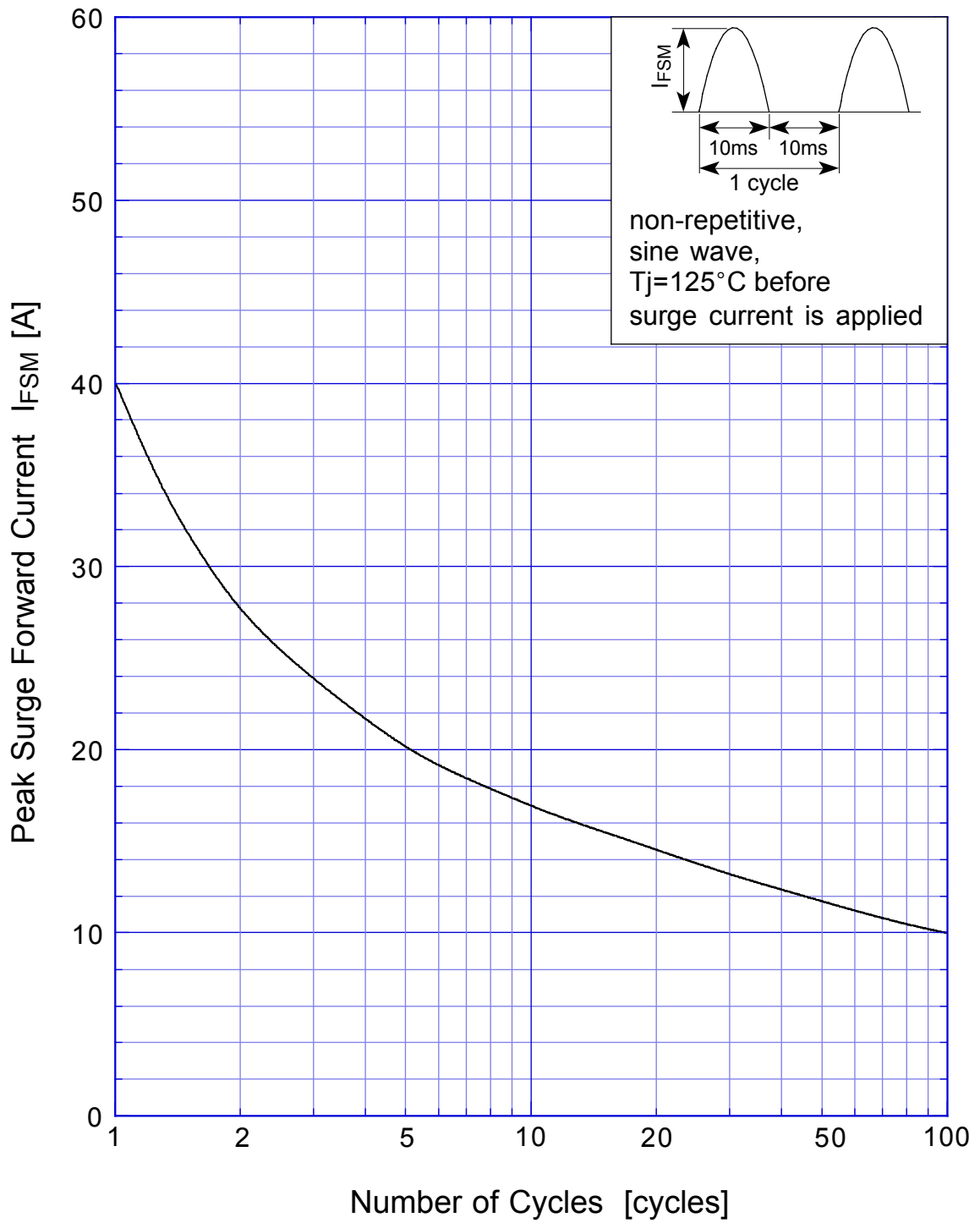

SBD Repetitive Surge Reverse Power Derating Curve

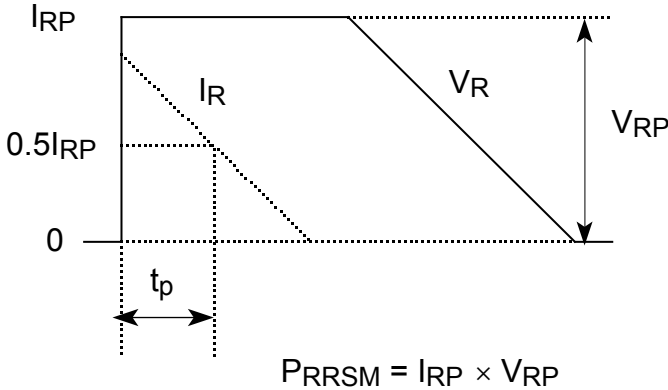
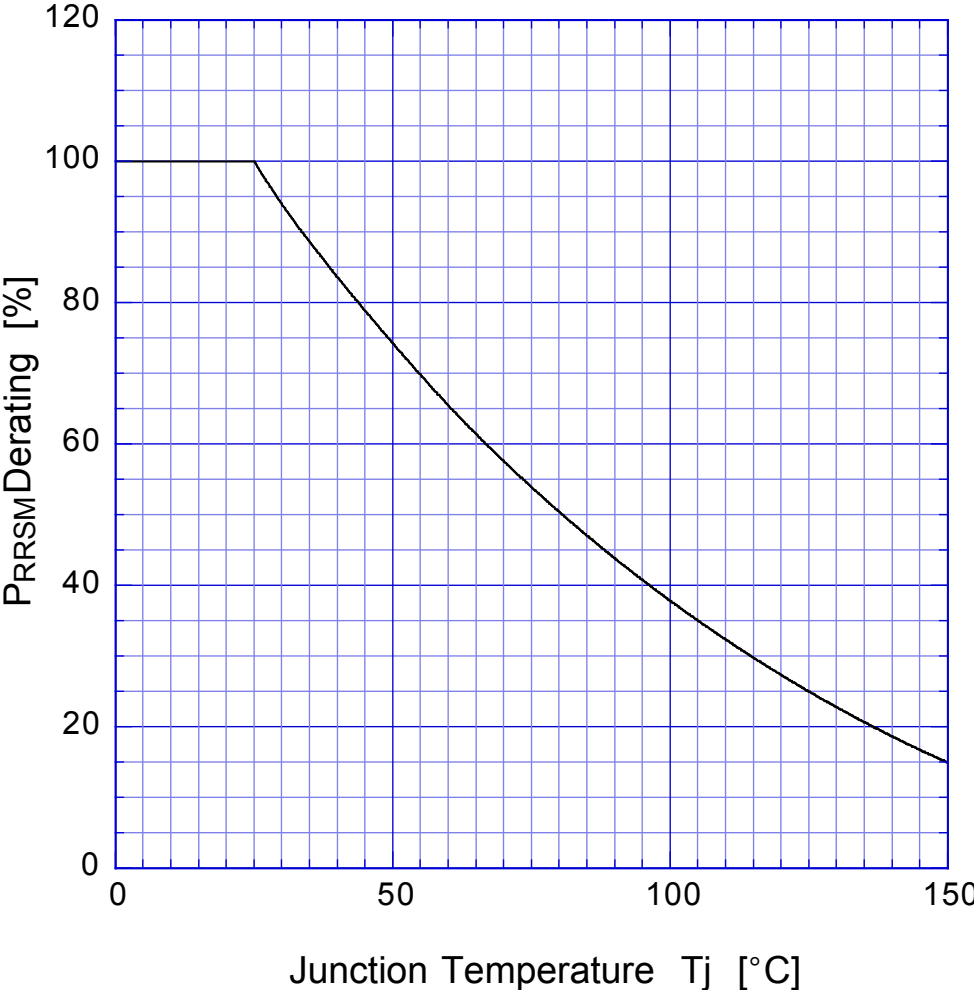

SBD

Repetitive Surge Reverse Power Capability

